

# Bonali

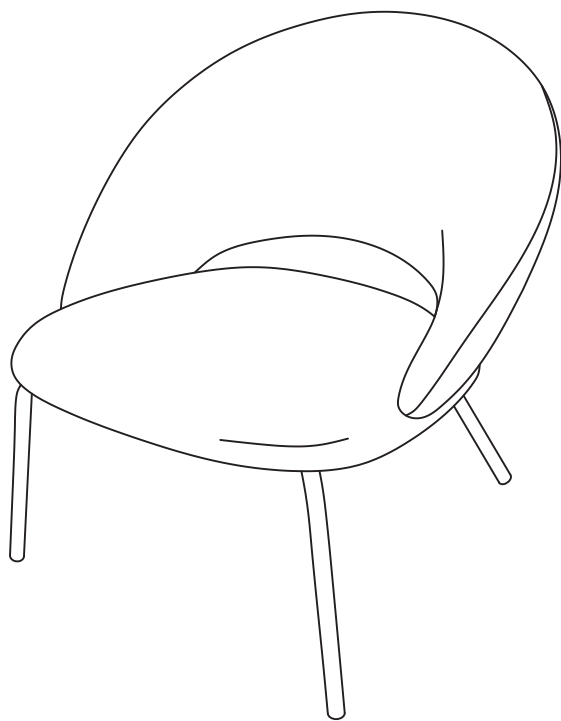

Kave

ED01

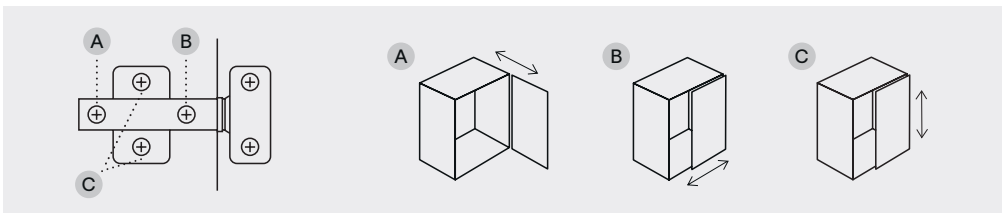
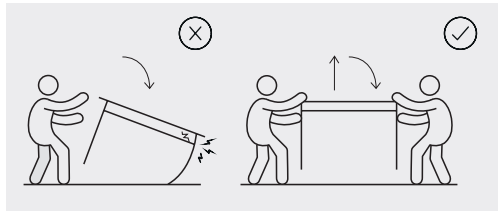
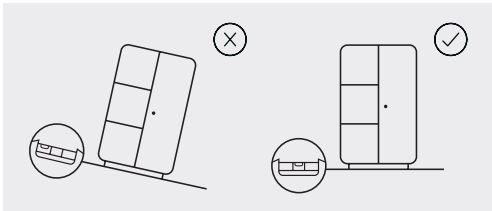
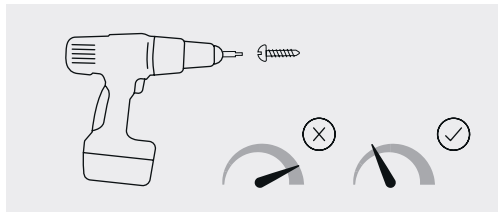
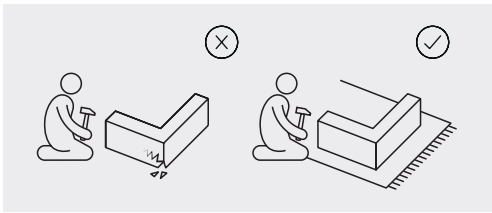
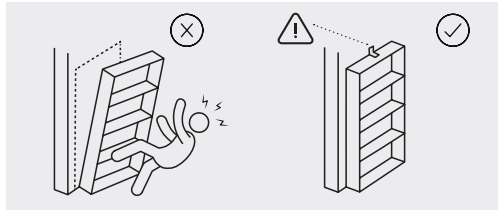
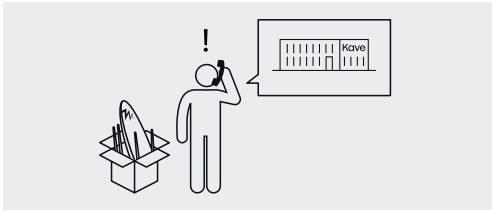
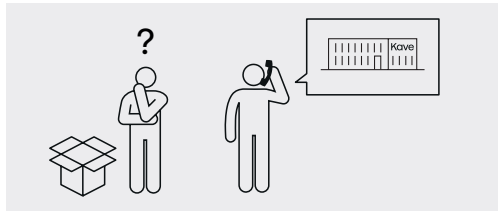
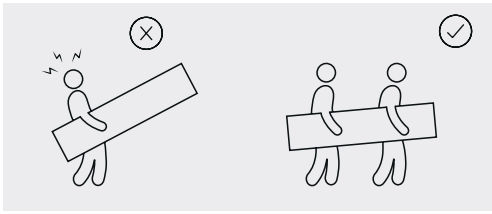



10 min



x1



x1

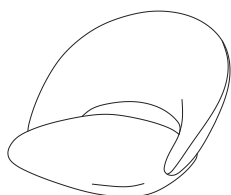

**A**×1

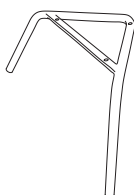

**B**×1

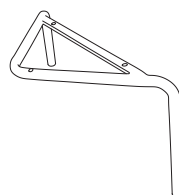

**C**×1

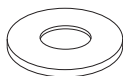

**D**×4



**E**×4



**F**×1  
M5

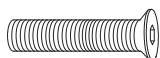

**G**×2



**H**×1  
M4

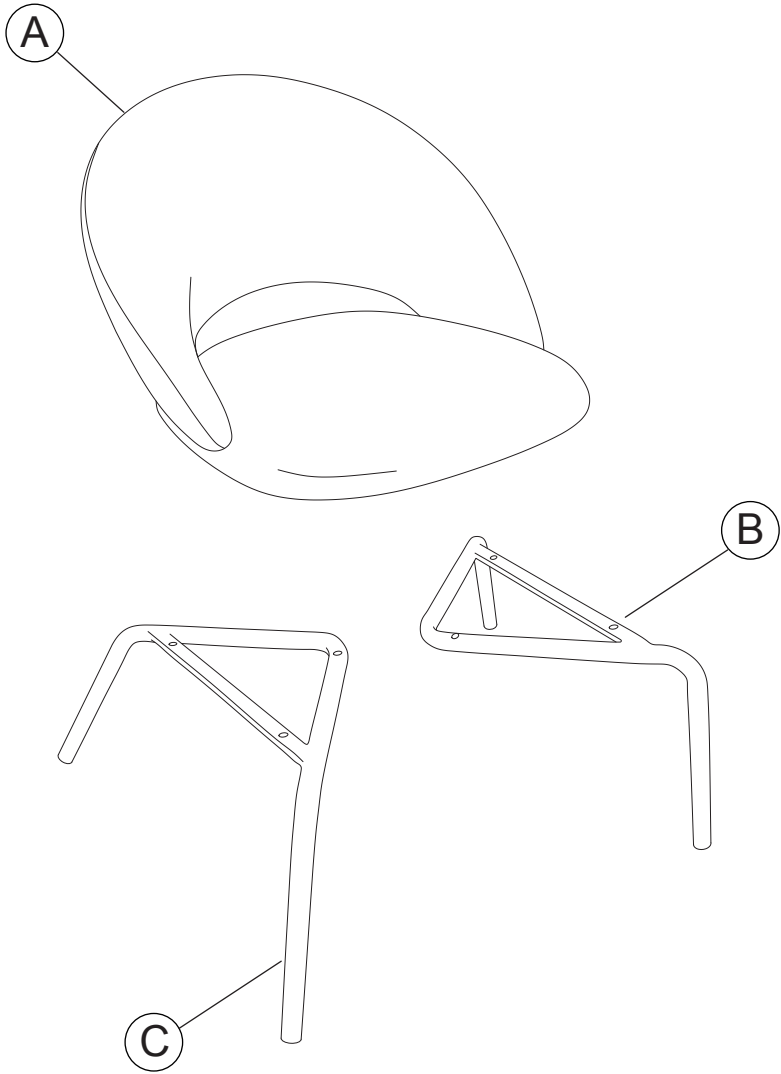

1

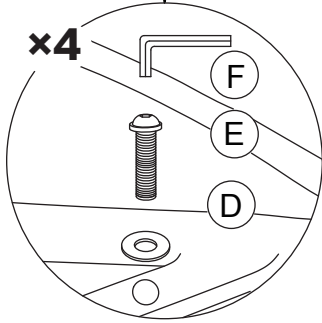
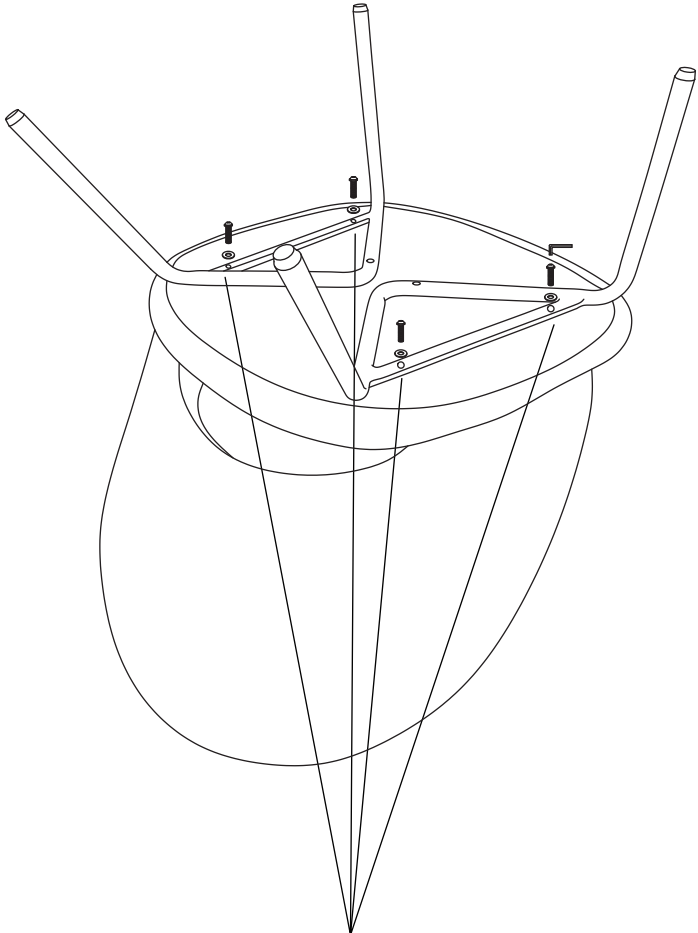

2

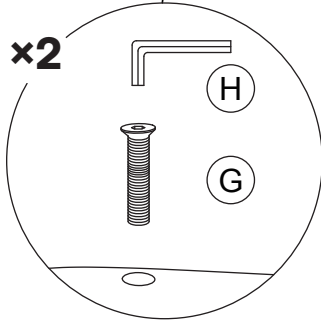
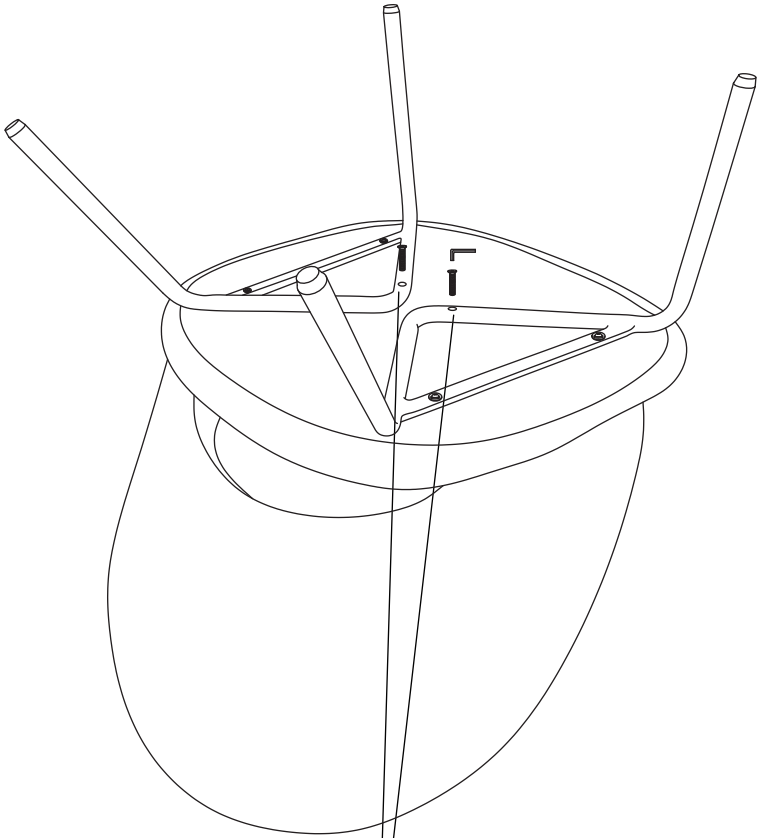

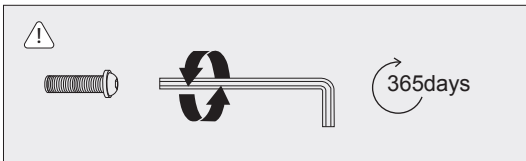
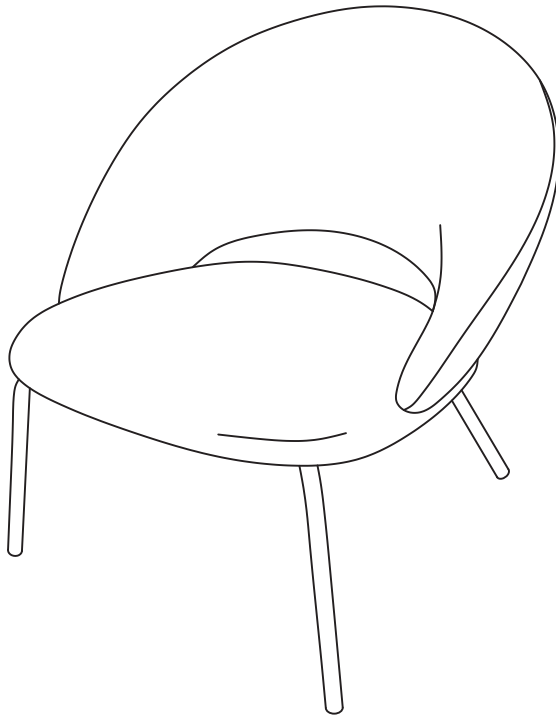

# Kave

**Julià Grup Furniture Solutions S.L.**

B-17616277

Pol. Ind. Bosc d'en Cuca  
C/ Tallers, 14. 17410 Sils, Spain  
contact@kavehome.com



IT: PAP 22, Carta.  
Verifica le disposizioni del tuo comune.