

Sanile

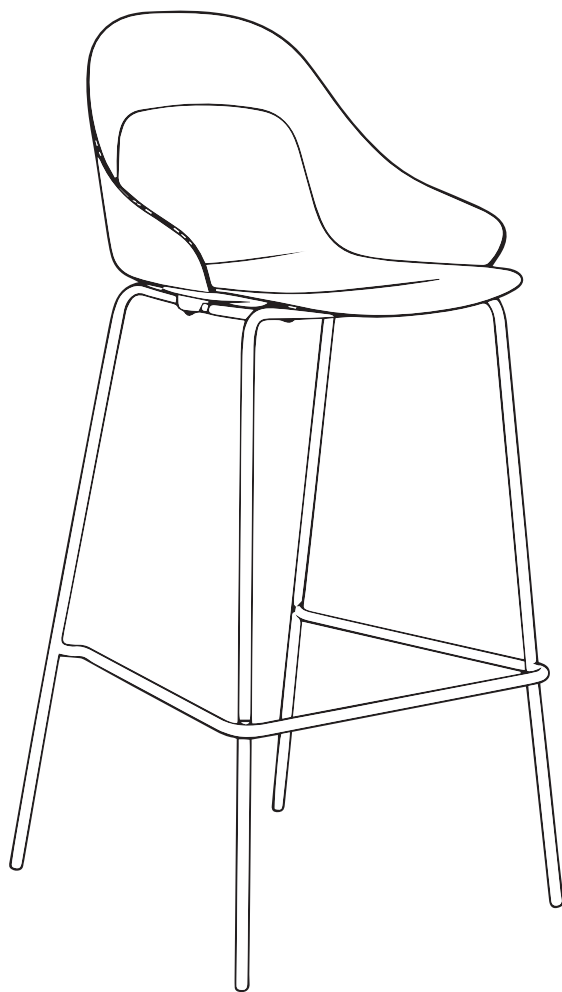

Kave

ED01

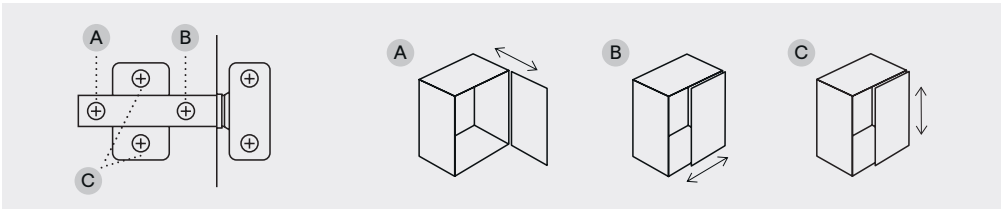
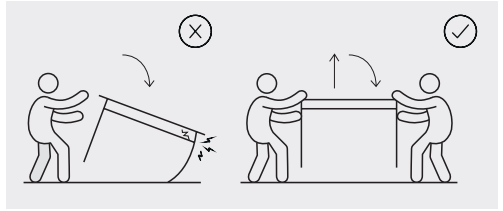
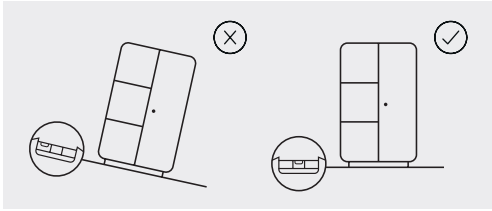
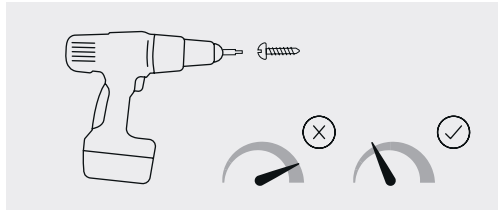
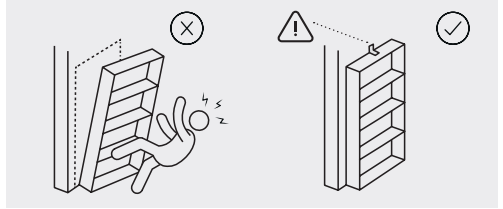
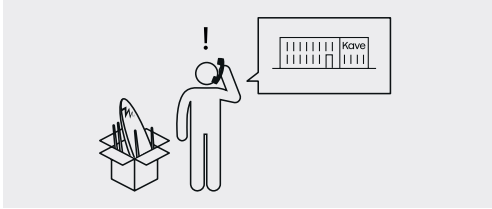
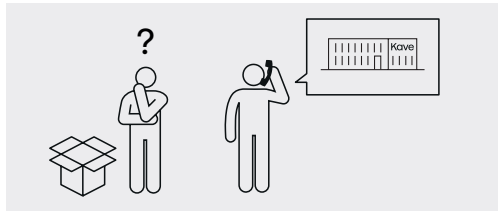



10 min



x1



x1

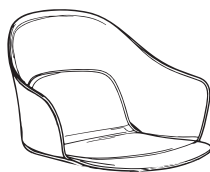

A x1

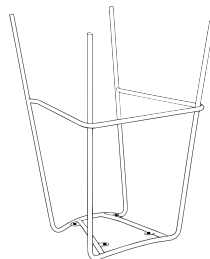

B x1



C x4
6x16mm



D x4
M6



E x4
6x18x2mm



F x1
M4

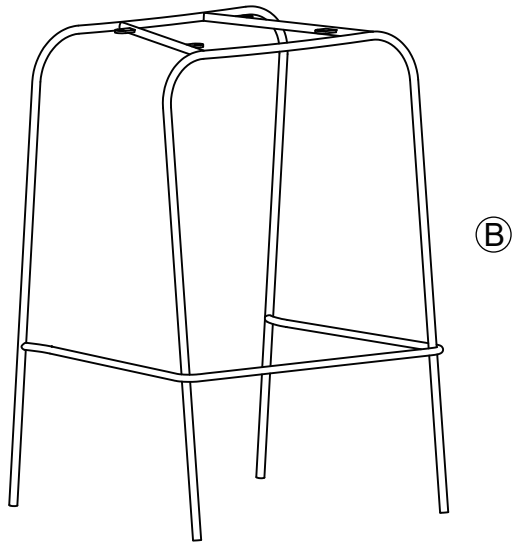
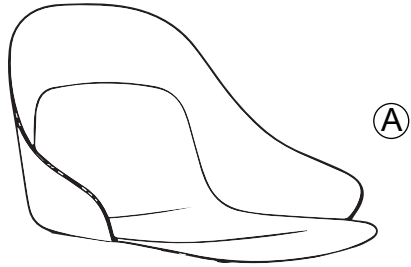

1

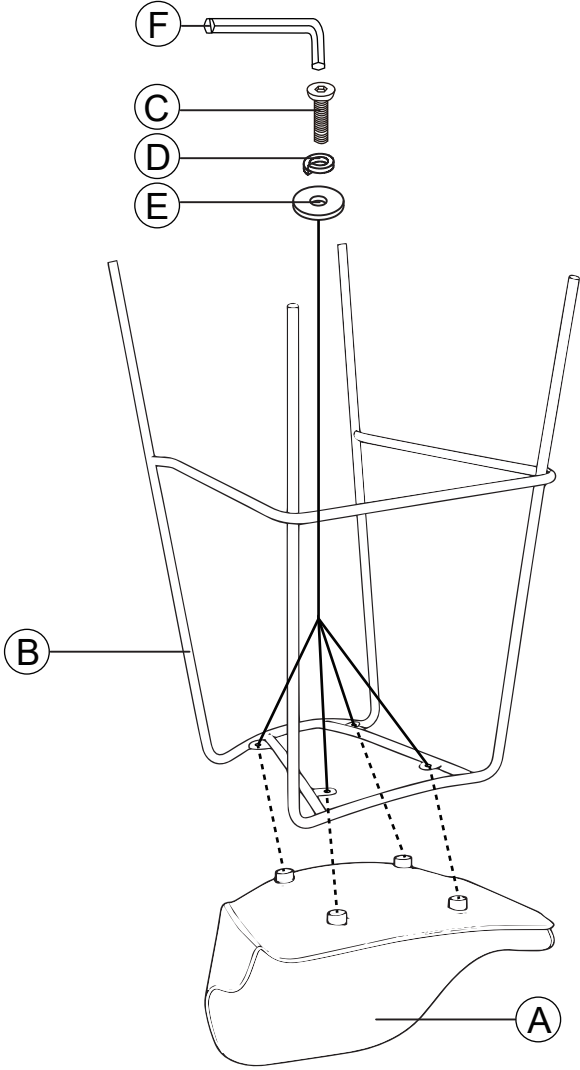

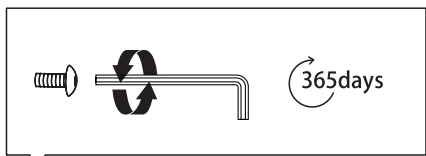
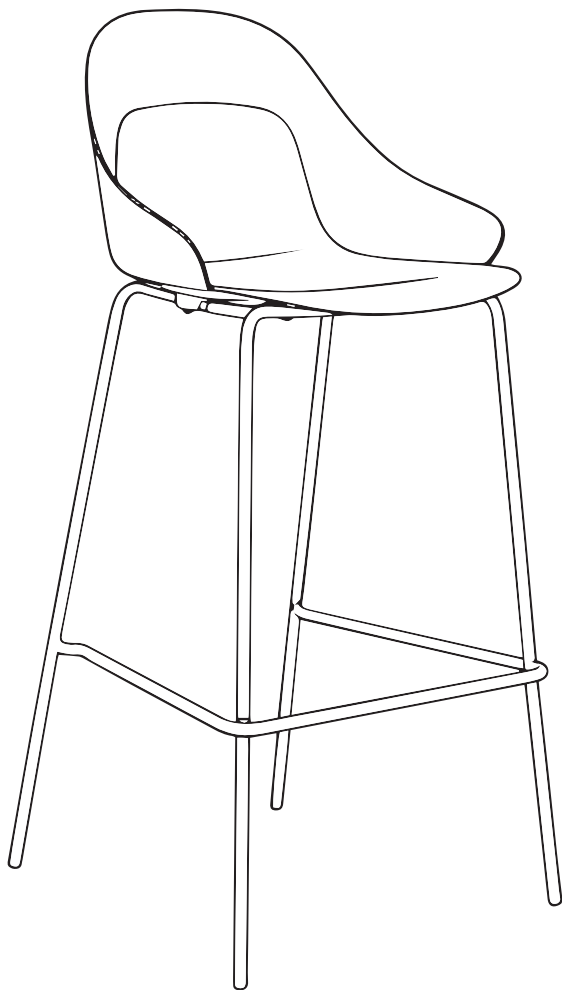

Kave

Julià Grup Furniture Solutions S.L.

B-17616277

Pol. Ind. Bosc d'en Cuca
C/ Tallers, 14. 17410 Sils, Spain
contact@kavehome.com



IT: PAP 22, Carta.
Verifica le disposizioni del tuo comune.