

Asinara

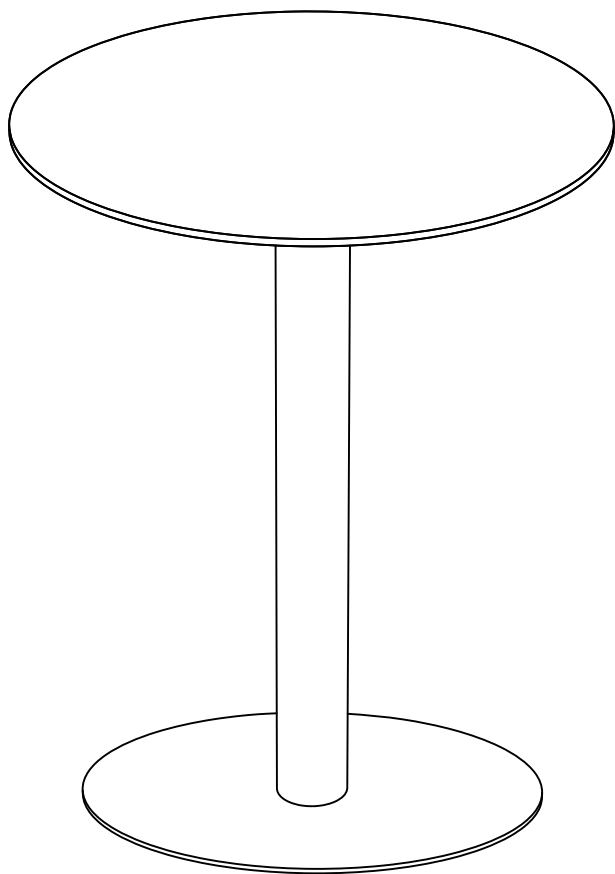

Kave

ED01

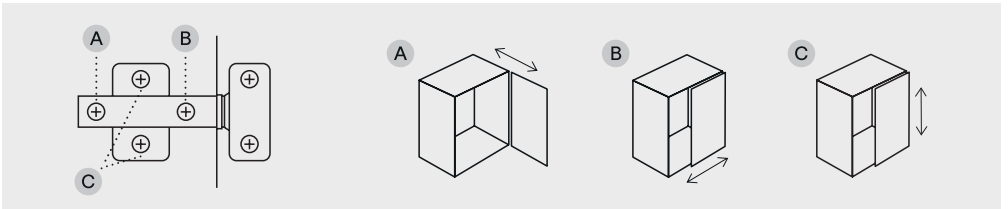
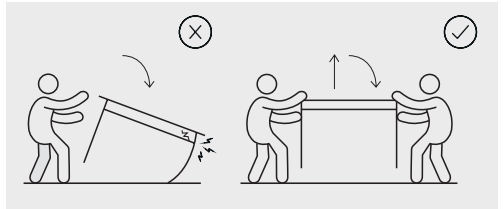
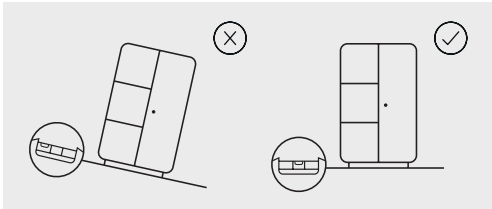
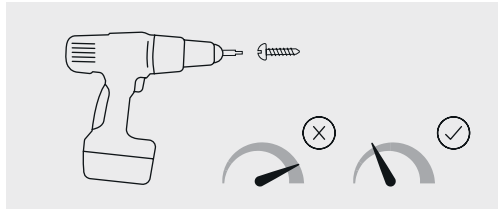
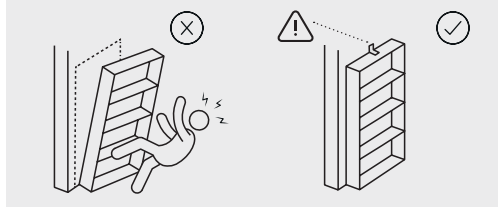
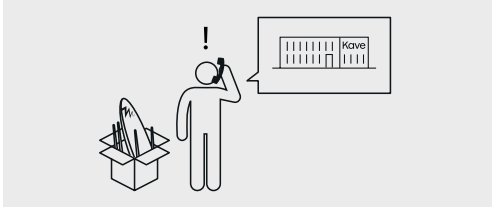
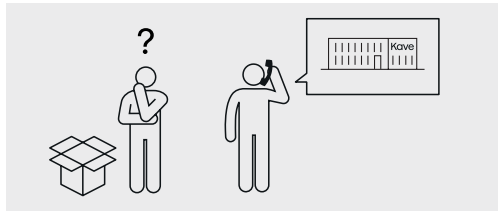
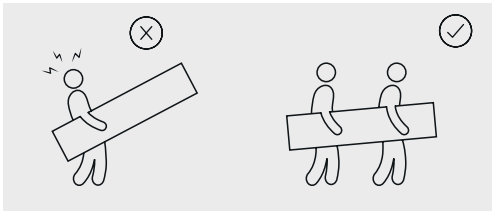



5min



x1



x1



x2



Ax1

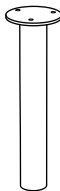

Bx1



Cx1



Dx3
M6x12mm



Ex3
M6x10mm



Fx3
M6x12mm



Gx1
M4



Hx3
M8x30mm



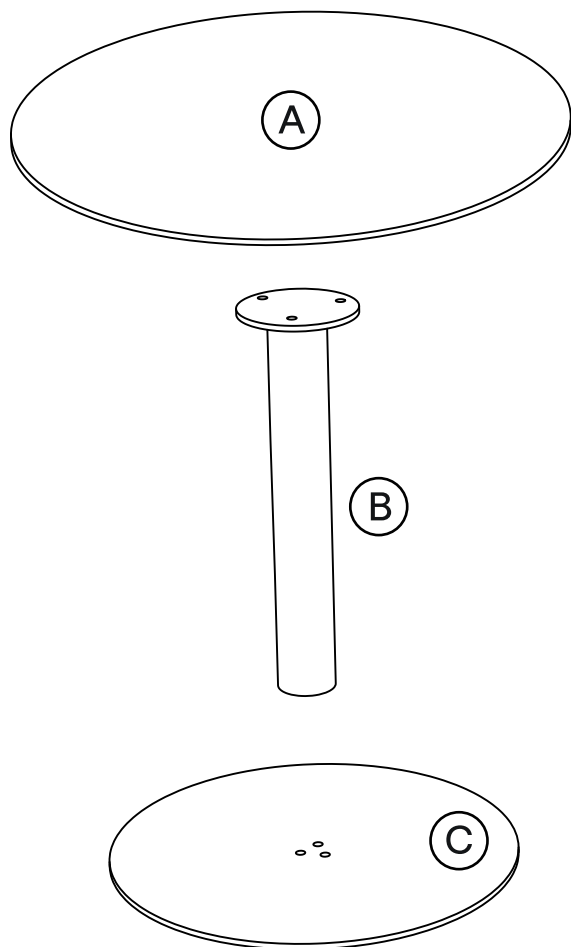

Ix1
M5

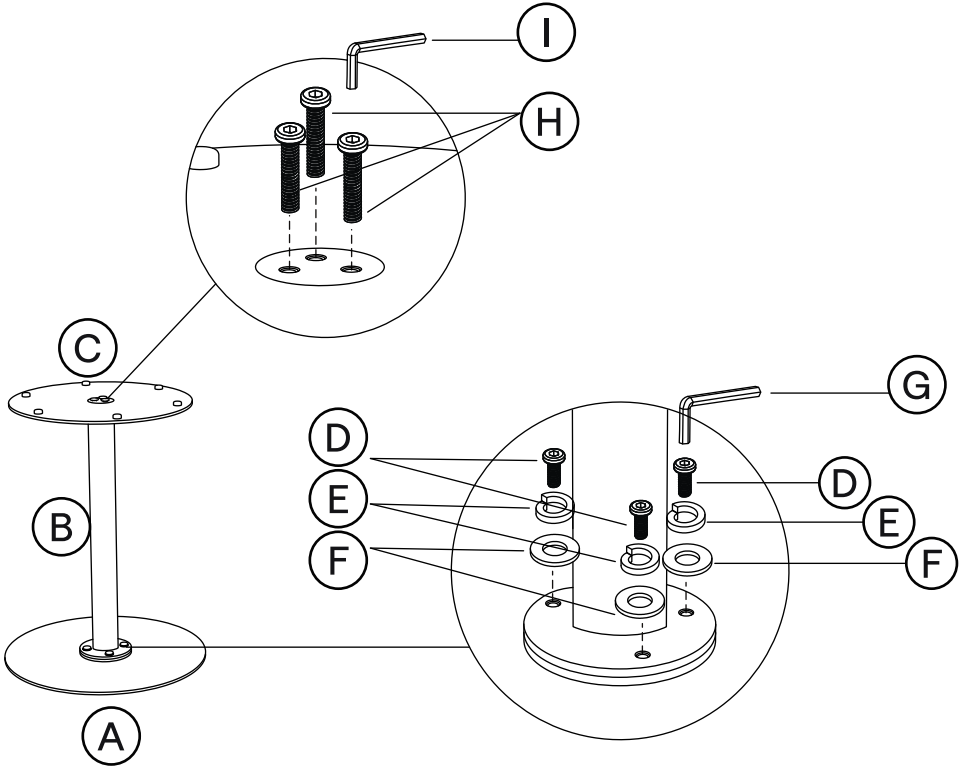

1



⚠ 50% ✓ 100% ✗



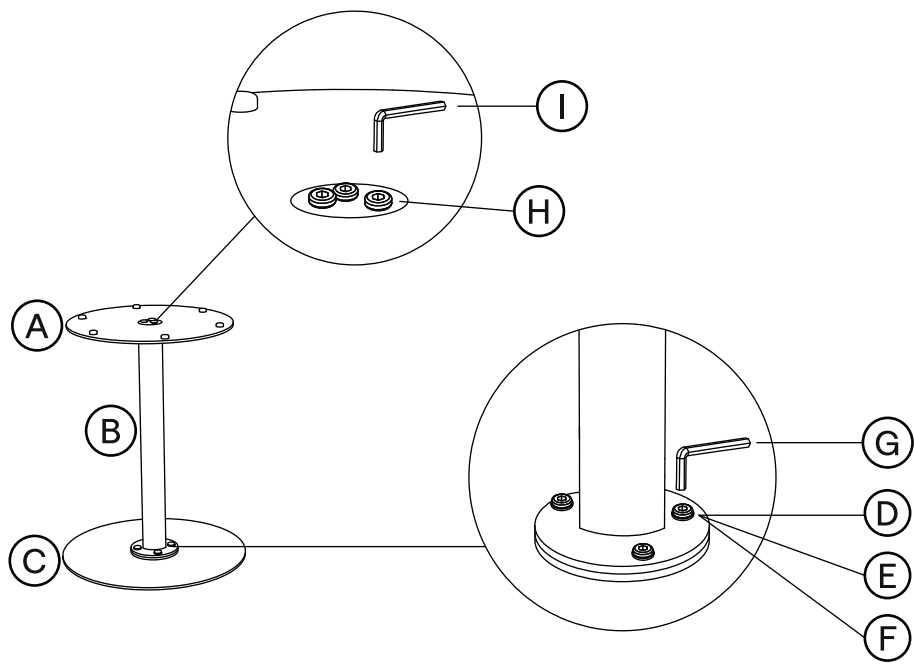

! 50% ✘ 100% ✔

The diagram shows two ways to tighten a screw. The 50% method, marked with a red 'X', shows a screw being tightened only halfway. The 100% method, marked with a black checkmark, shows the screw being tightened fully.

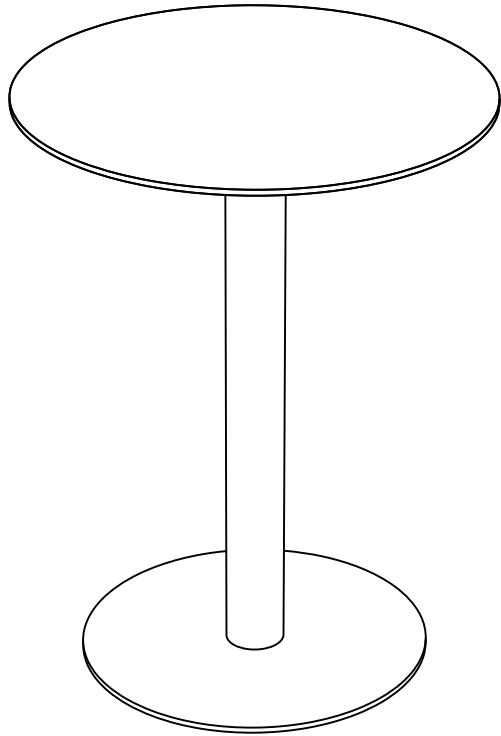

365 days



KG
Max 20kg

Kave

Julià Grup Furniture Solutions S.L.

B-17616277

Pol. Ind. Bosc d'en Cuca
C/ Tallers, 14. 17410 Sils, Spain
contact@kavehome.com



IT: PAP 22, Carta.
Verifica le disposizioni del tuo comune.