

# Mailen

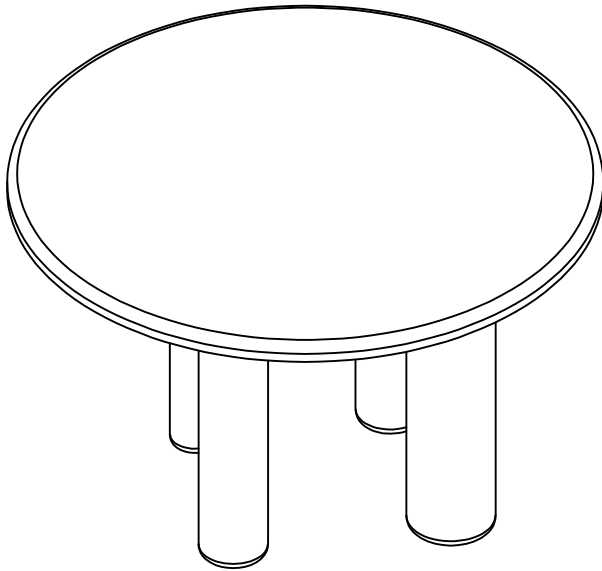

Kave

ED01

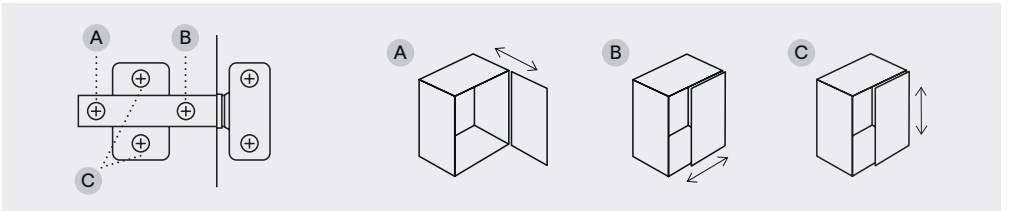
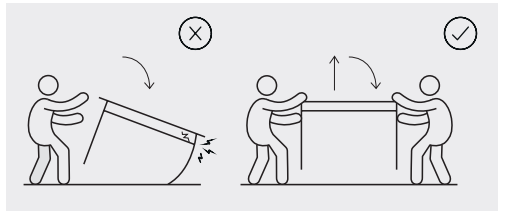
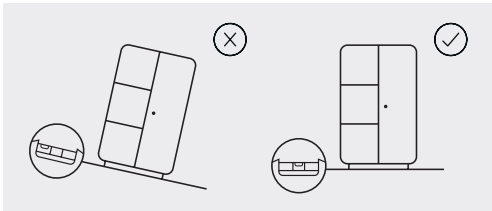
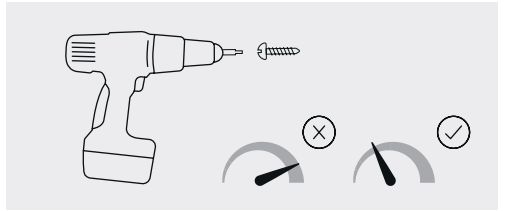
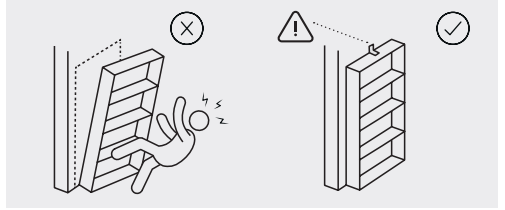
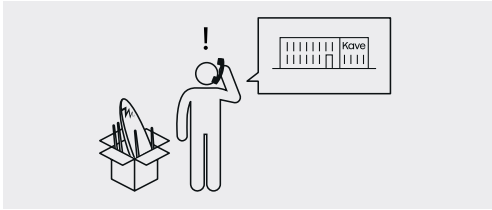
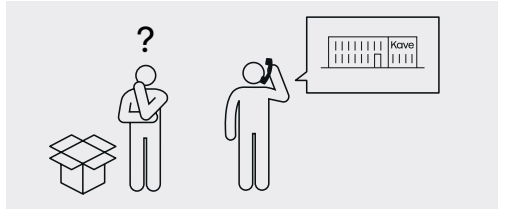
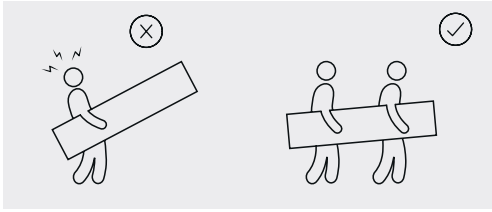



30 min



x2



x2



x1

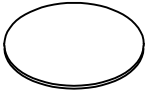

A x 1



B x 1



C x 2

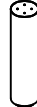

D x 1



E x 16  
M8 x 25mm



F x 16  
Ø8 x 25mm



G x 1  
5mm



H x 1  
140 x 140 x 5mm



I x 2  
160 x 160 x 5mm



J x 1  
200 x 200 x 5mm

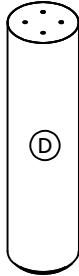
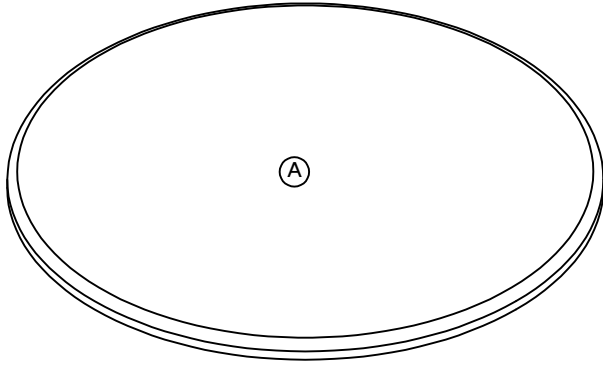

1

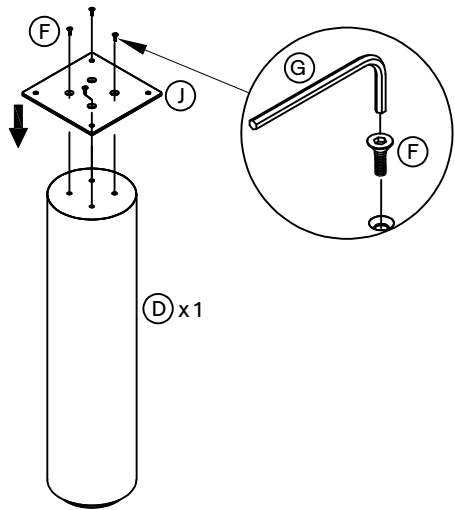
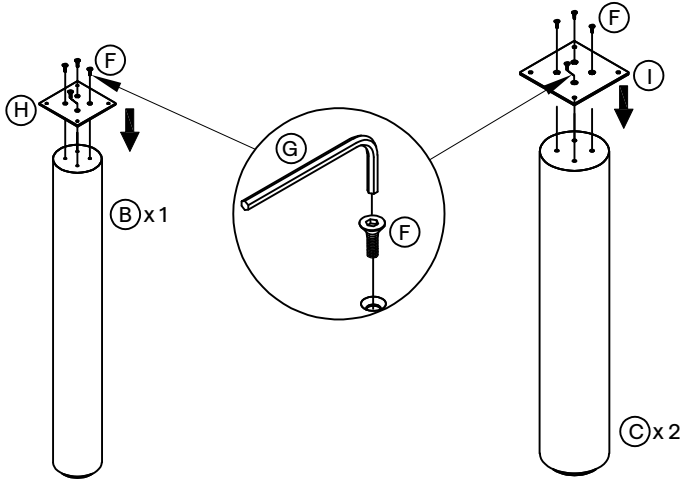

2

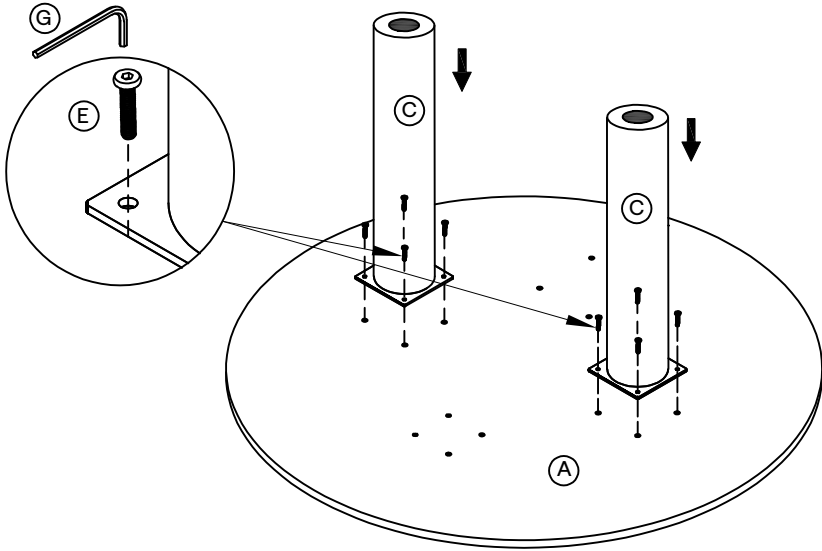

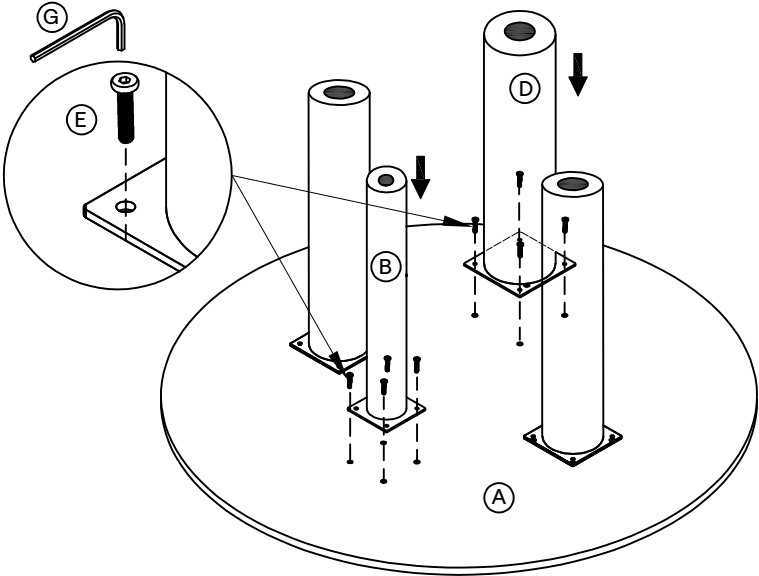

4

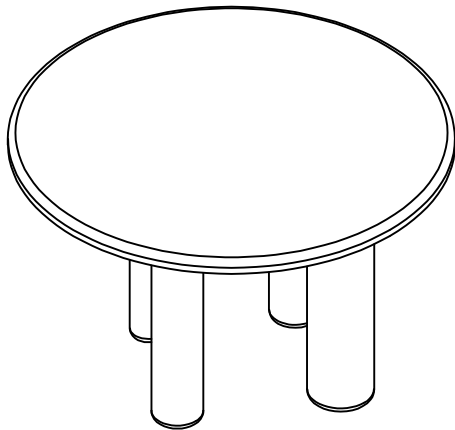
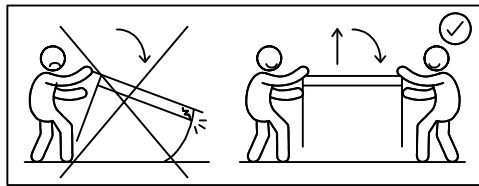
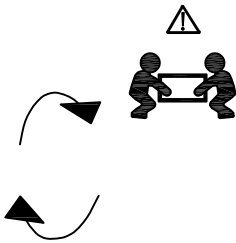
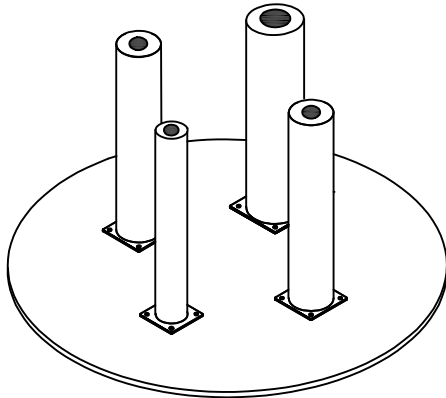







# Kave

**Julià Grup Furniture Solutions S.L.**

B-17616277

Pol. Ind. Bosc d'en Cuca  
C/ Tallers, 14. 17410 Sils, Spain  
contact@kavehome.com



IT: PAP 22, Carta.  
Verifica le disposizioni del tuo comune.