

# Patio

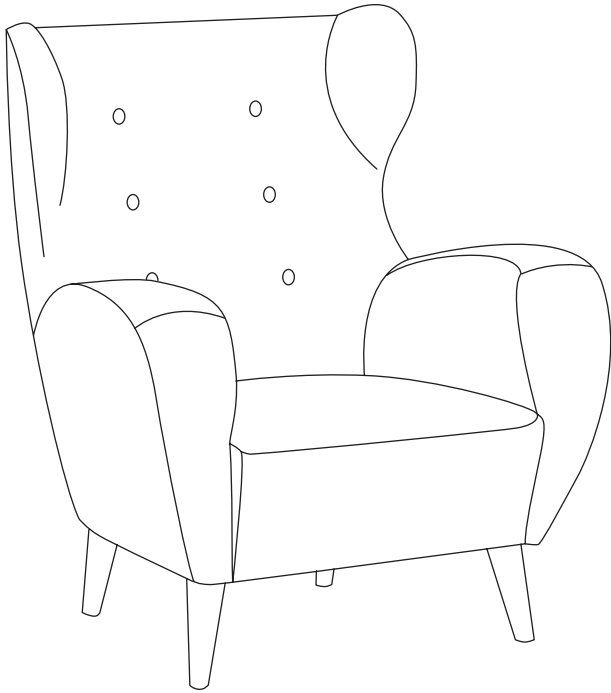

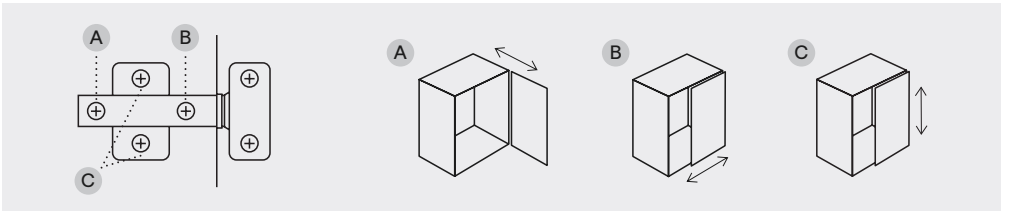

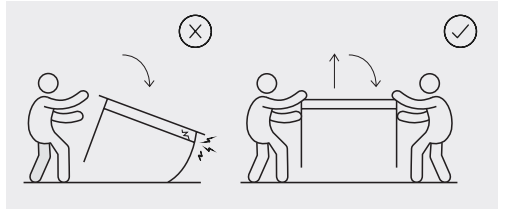
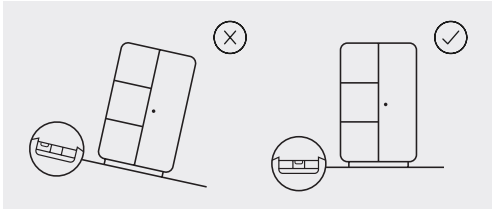
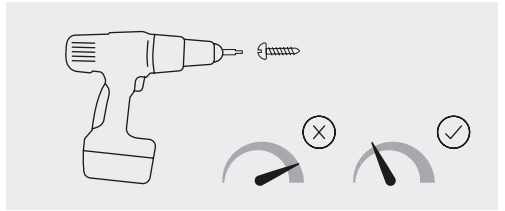
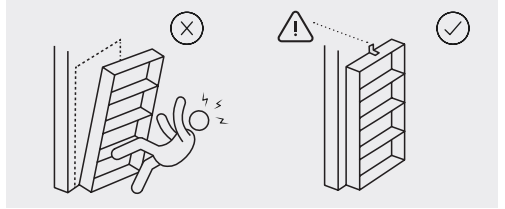
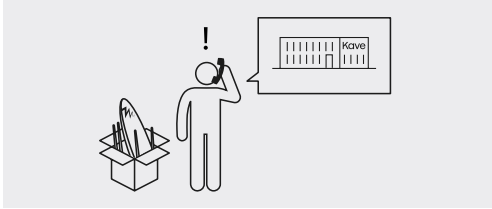
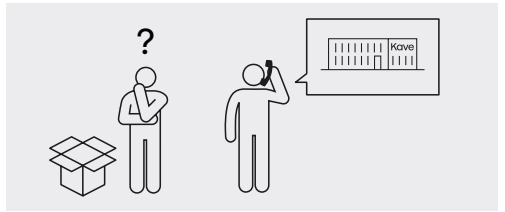
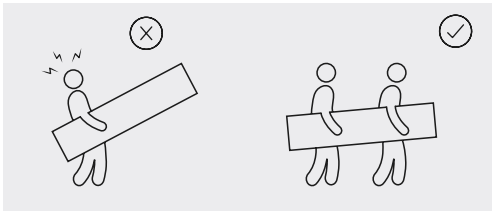

10 min

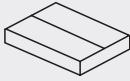

x2



x1

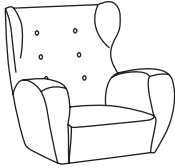

**A** x1



**B** x2



**C** x2



**D** x4  
M8xD15



**E** x1  
M8



**F** x4  
M8×60mm



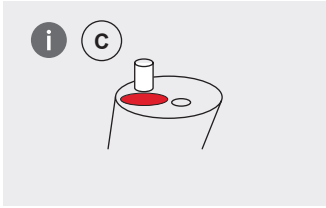
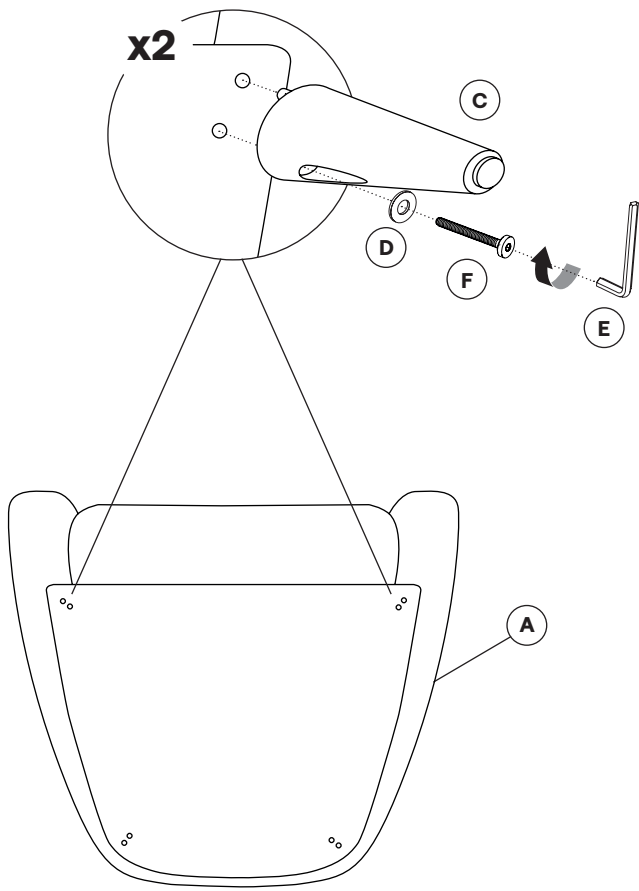

2

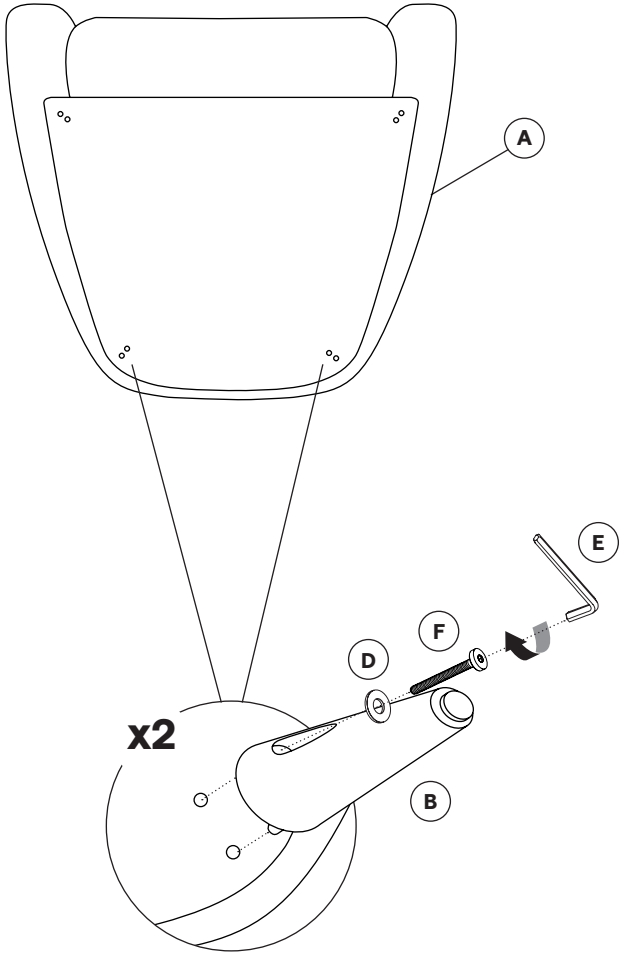

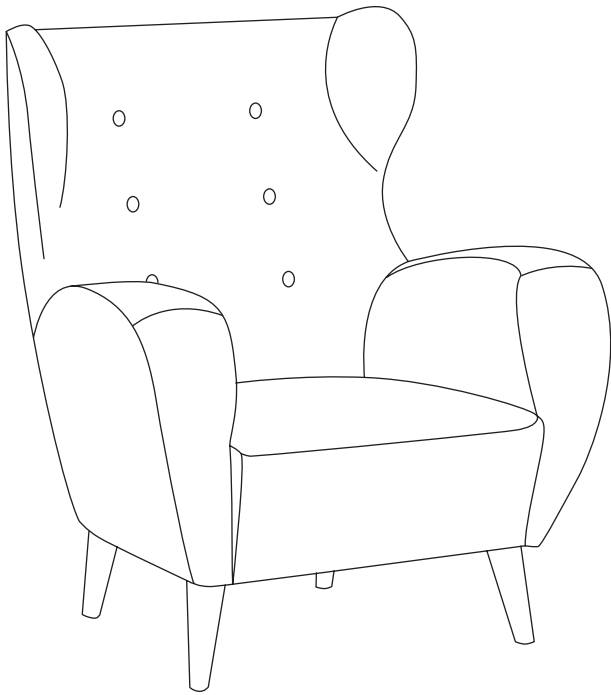

# Kave

**Julià Grup Furniture Solutions S.L.**

B-17616277

Pol. Ind. Bosc d'en Cuca  
C/ Tallers, 14. 17410 Sils, Spain  
contact@kavehome.com



IT: PAP 22, Carta.  
Verifica le disposizioni del tuo comune.