

Nora

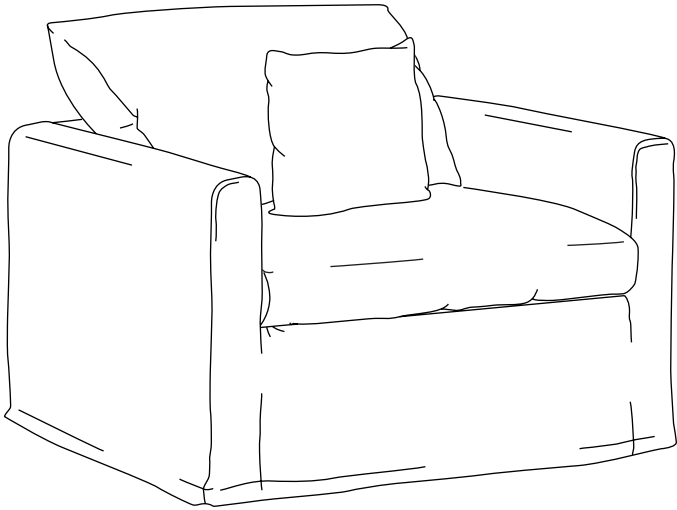

Kave

ED02

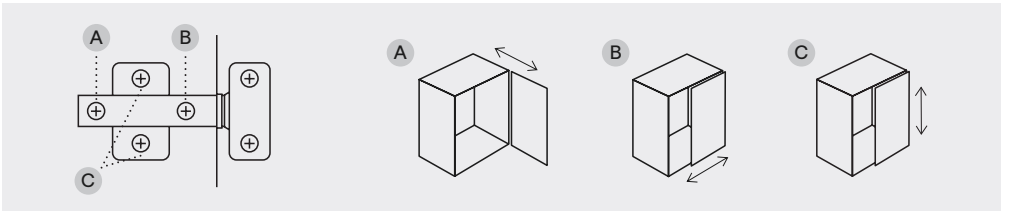
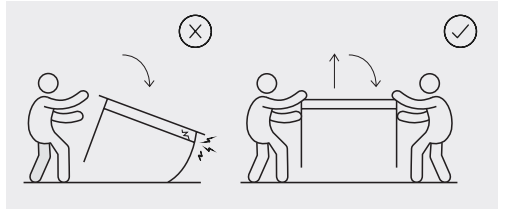
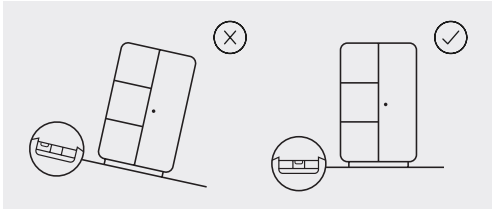
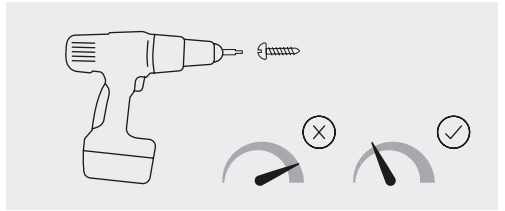
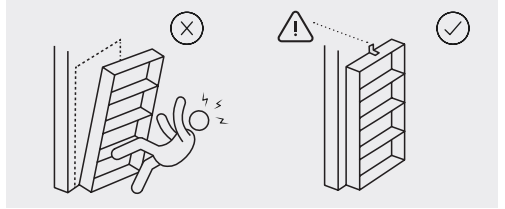
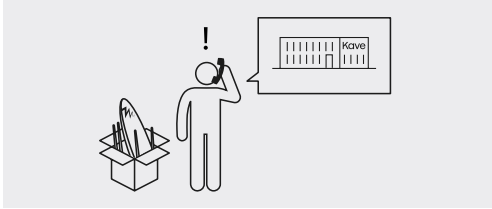
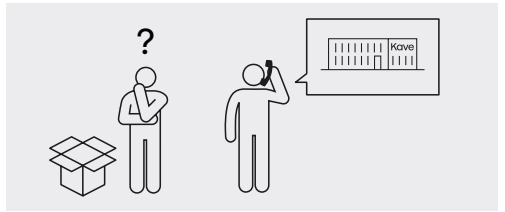
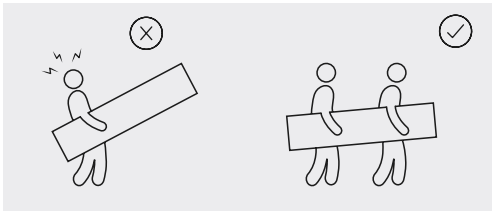



5 min



x2



x1

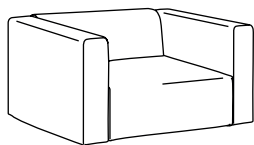

A x1



B x1



C x1

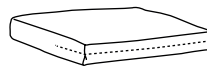

D x1

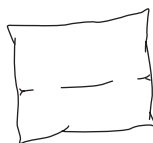

E x1

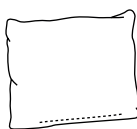

F x1



G x1



H x1



I x1



J x1

1

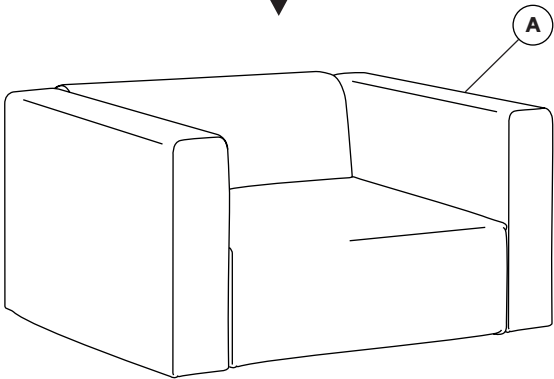
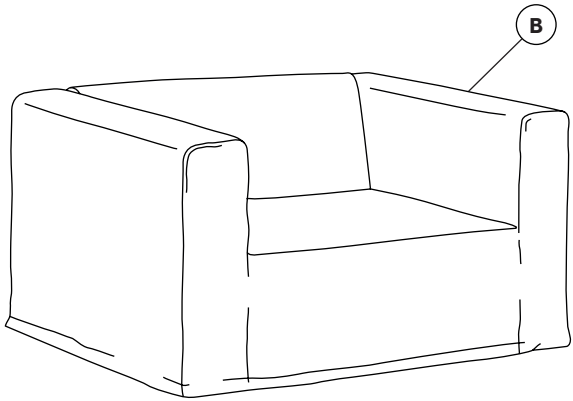

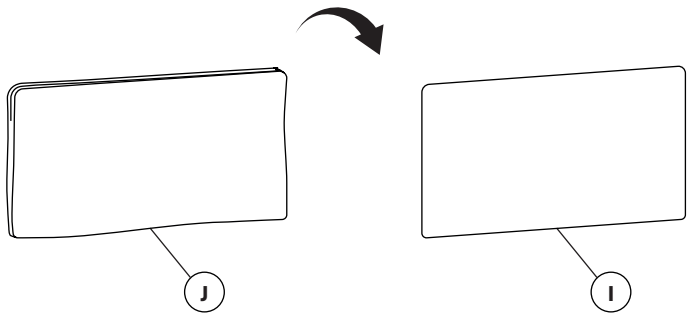
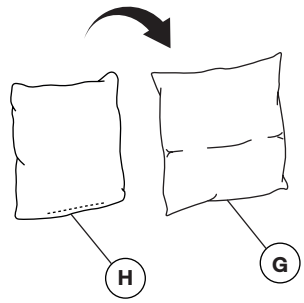
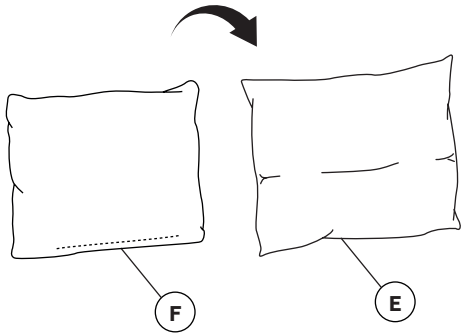
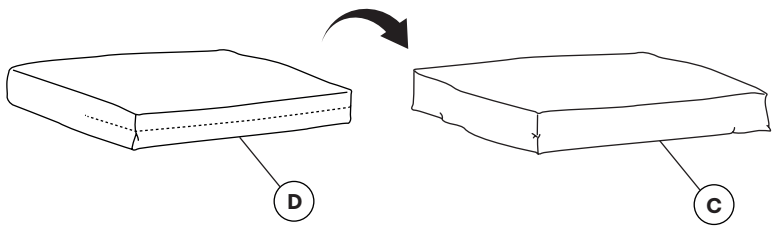

3

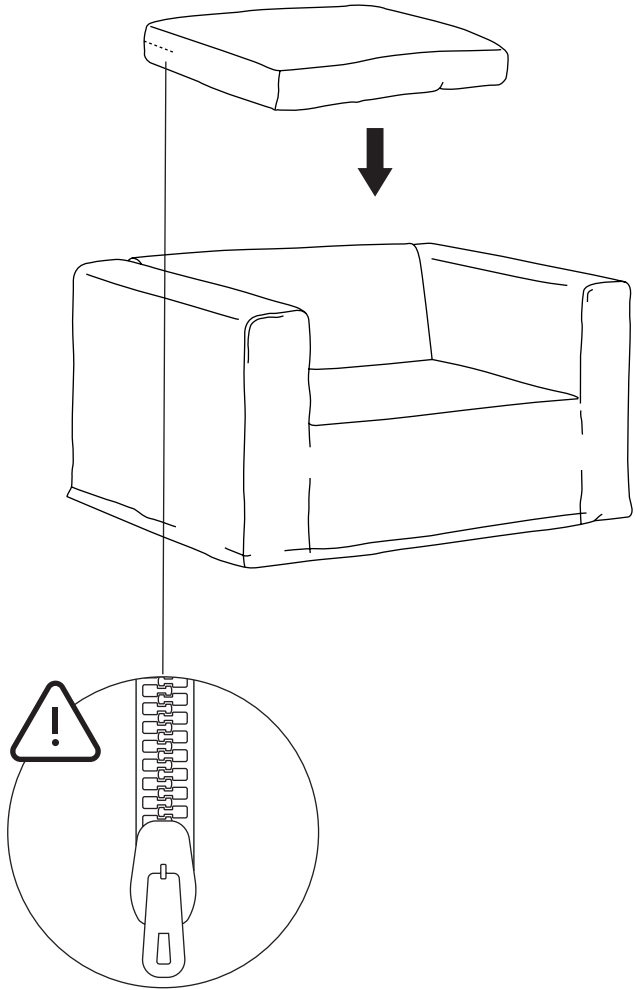

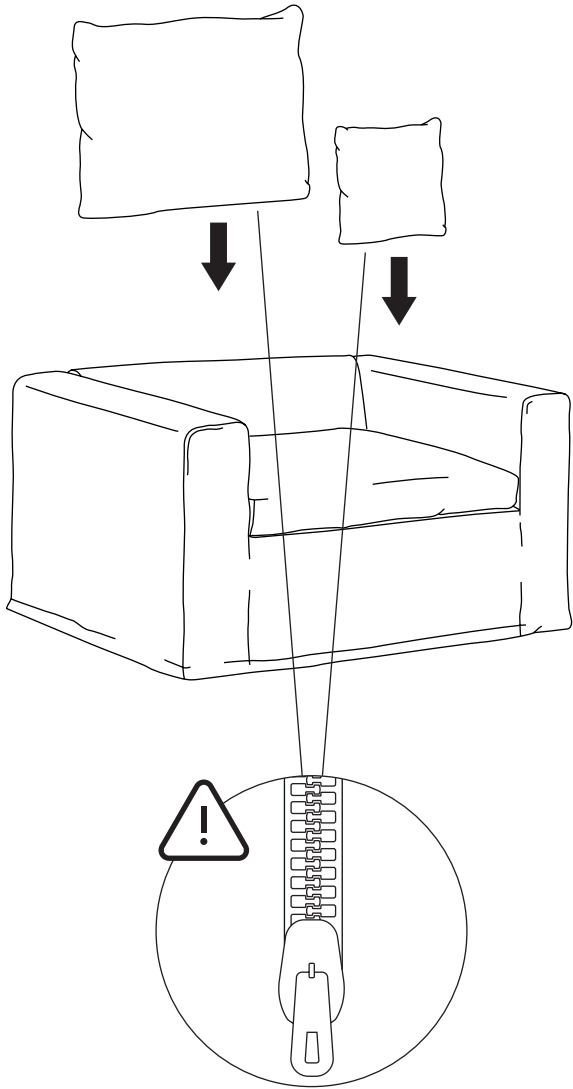

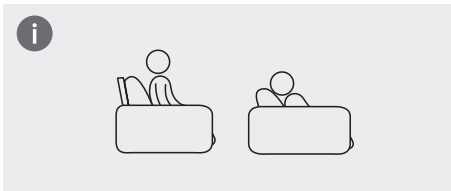
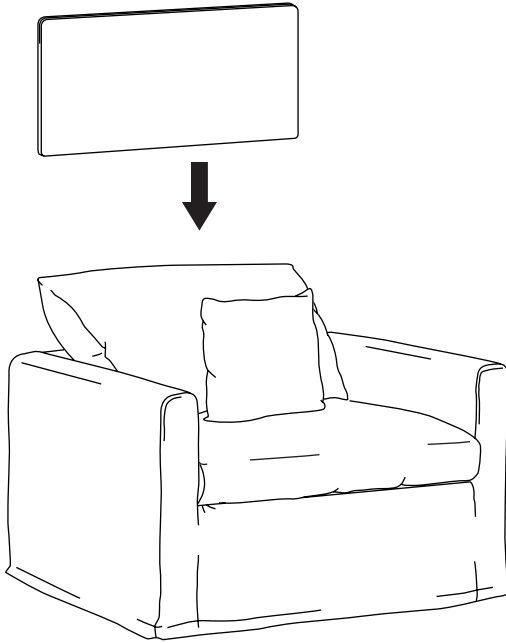

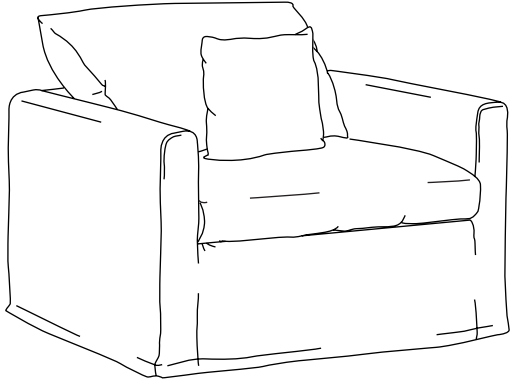

Kave

Julià Grup Furniture Solutions S.L.

B-17616277

Pol. Ind. Bosc d'en Cuca
C/ Tallers, 14. 17410 Sils, Spain
contact@kavehome.com



IT: PAP 22, Carta.
Verifica le disposizioni del tuo comune.