

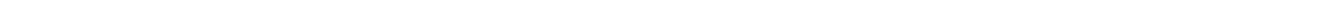

**C253 - C255 / C288 - C290 / C309 - C310 / C379**

---

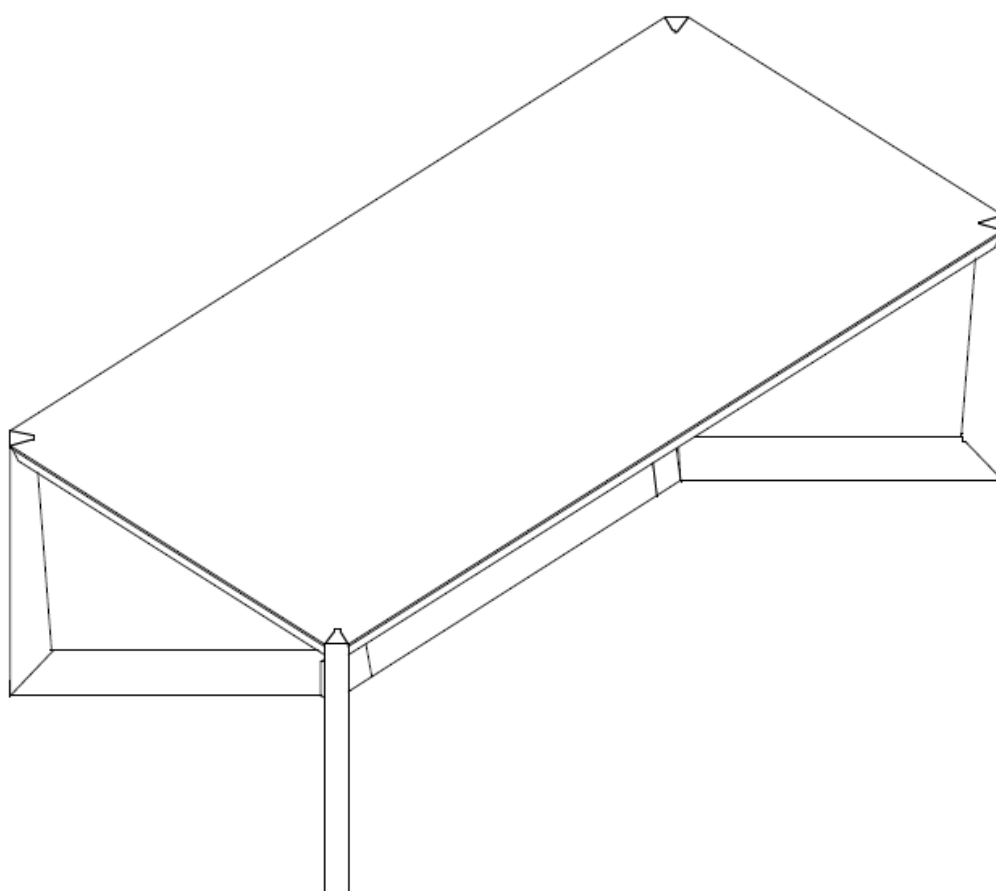

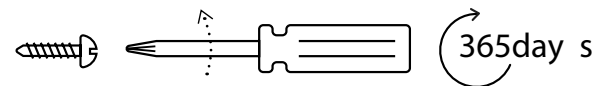
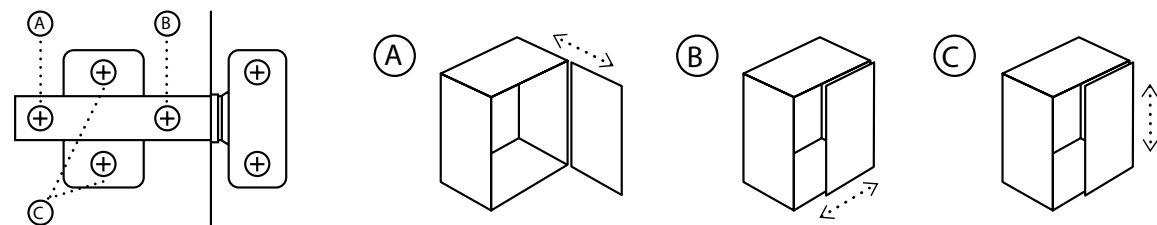
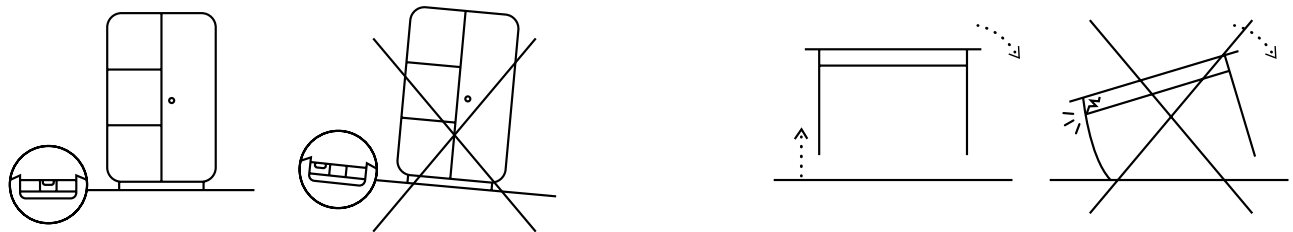
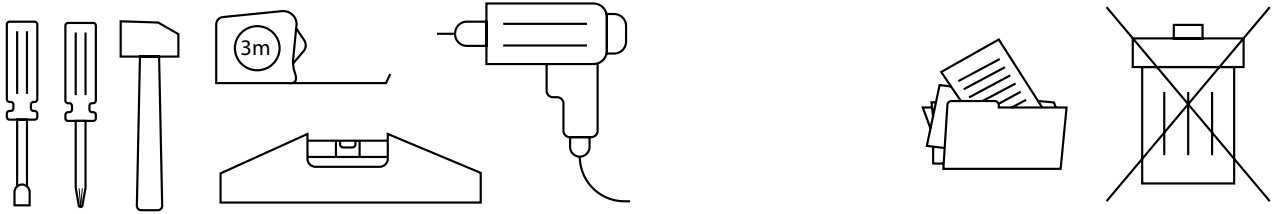
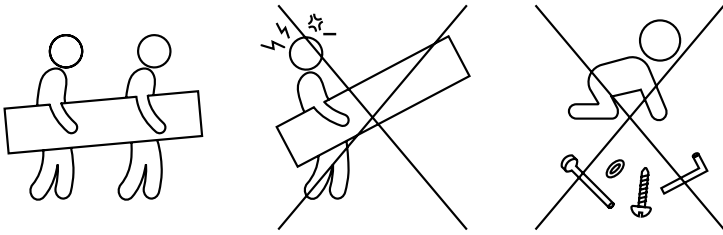



25 min

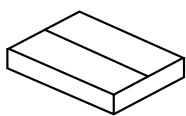

x2



x1

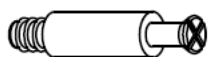

Ax2



Bx2 (ø15x13,5)

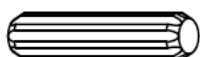

Cx8 (ø8x30)

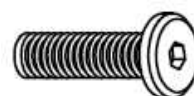

Dx4 (M6x15)



Fx1 (M4)



(1)x1

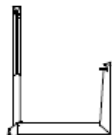

(2)x2

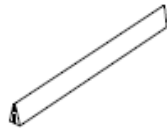

(3)x1

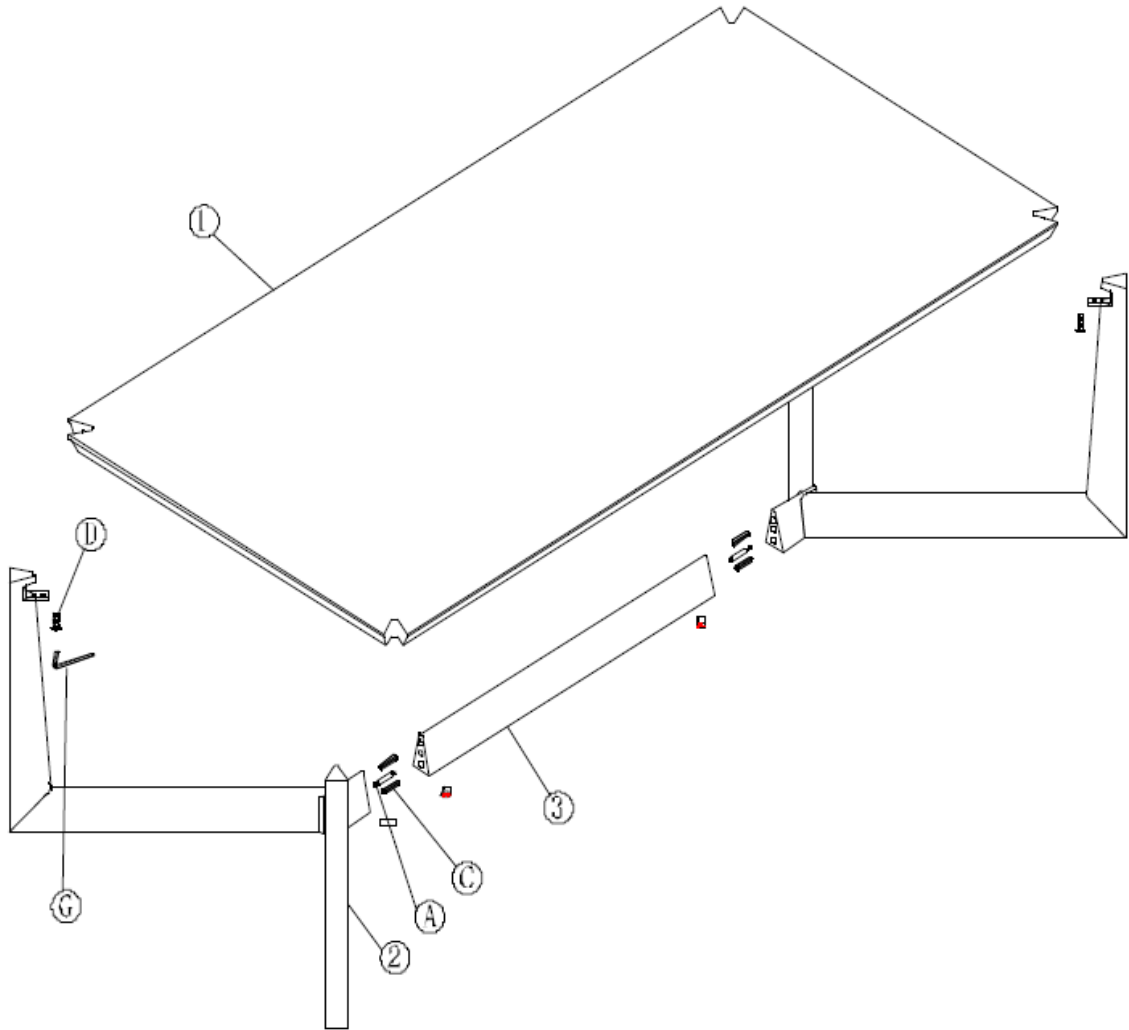

1

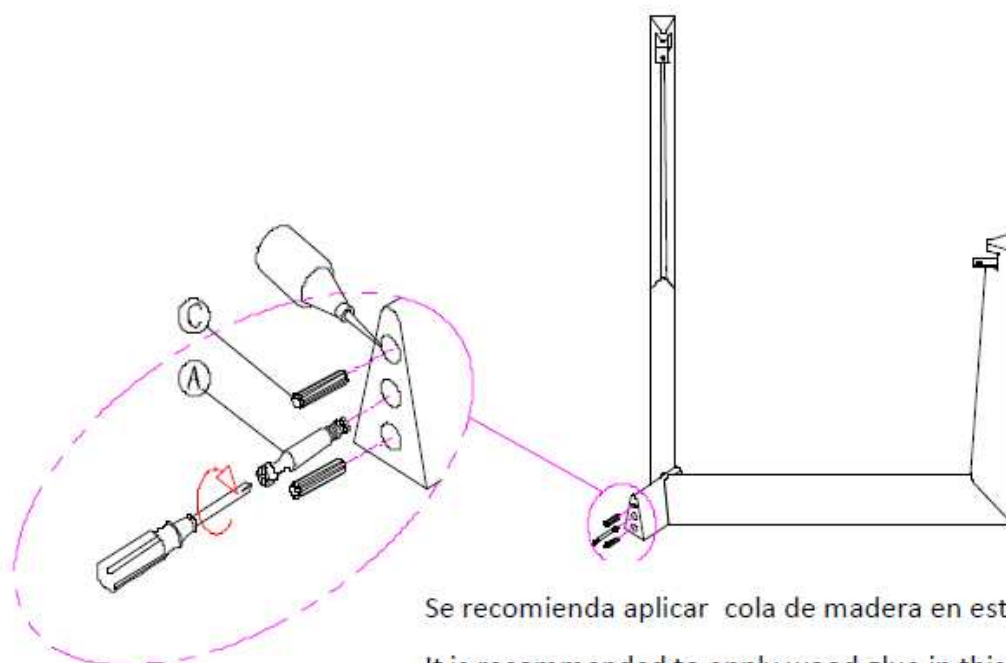

Se recomienda aplicar cola de madera en este paso.

It is recommended to apply wood glue in this step.

Recommandé d'appliquer colle à bois dans cette étape.



2

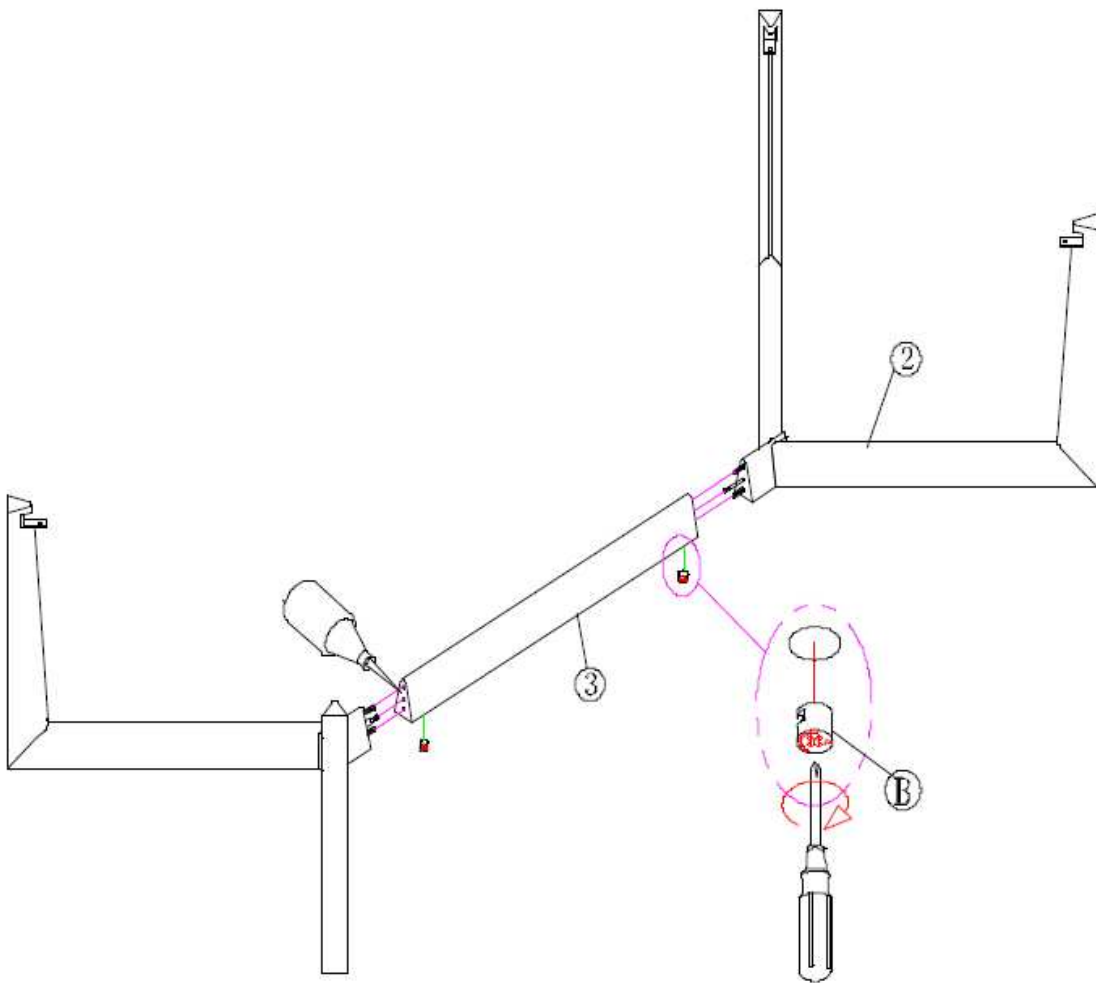



3

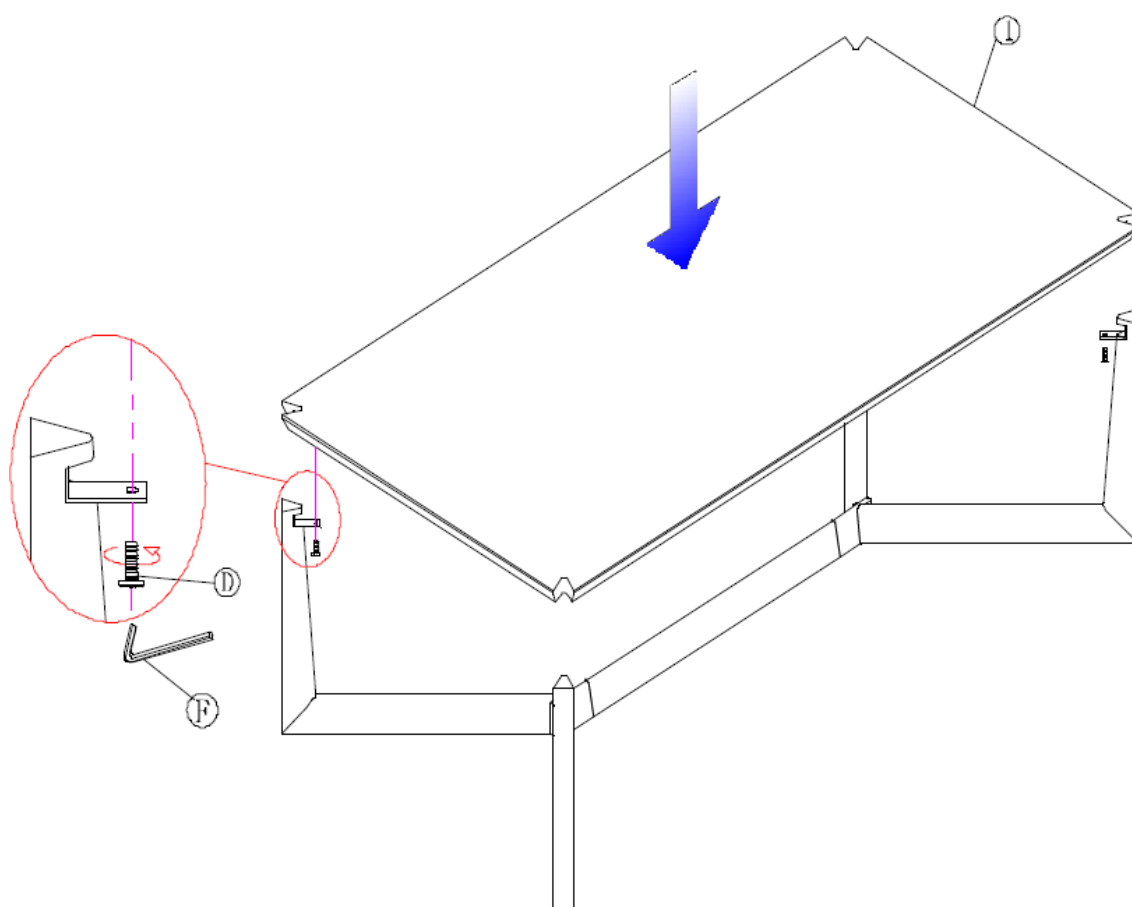

**JULIÀ GRUP Furniture Solutions S.L.**

B-17616277

Pol. Ind. Bosc d'en Cuca

C / Tallers, 14

17410 Sils SPAIN

[info@juliagrup.com](mailto:info@juliagrup.com)